

PKH.EP.E3.I

Tough pneumatically driven stainless steel ball valve with 3-pcs housing and M3- casing length.



Technical data

SIZE

DN15 (1/2") bis DN80 (3")

NORMS

- Internal thread ISO 7/1
- Mounting flange ISO 5211
- Casing length acc. DIN 3203 - M3

FLOW MEDIUM

Neutral gases and fluids. For aggressive medium see material resistance table. Medium which lead to an increase of operating torque could require other actuator sizes.

FLOW DIRECTION

Random

MATERIALS

- Body: 1.4408
- Ball and Stem: 1.4401
- Stem seal, ball seal: PTFE, glassfiber

TEMPERATURE

-10° to +200°C (depending on operating pressure)

PRESSURE-/TEMPERATURE

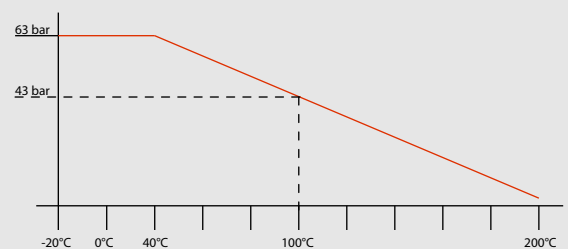

OPERATION METHOD

Pneumatic actuators, double- or single acting, spring open (NC) or spring close (NC).

CONTROL PRESSURE / MEDIUM

5,5 bar. Compressed air or inert gases acc. PNEUROP/ISO class 4, other control medium and pressure on request.

OPTIONS

- 3/2- or 5/2-way-solenoid valve
- Positioner
- Mechanical microswitches or inductive sensors.

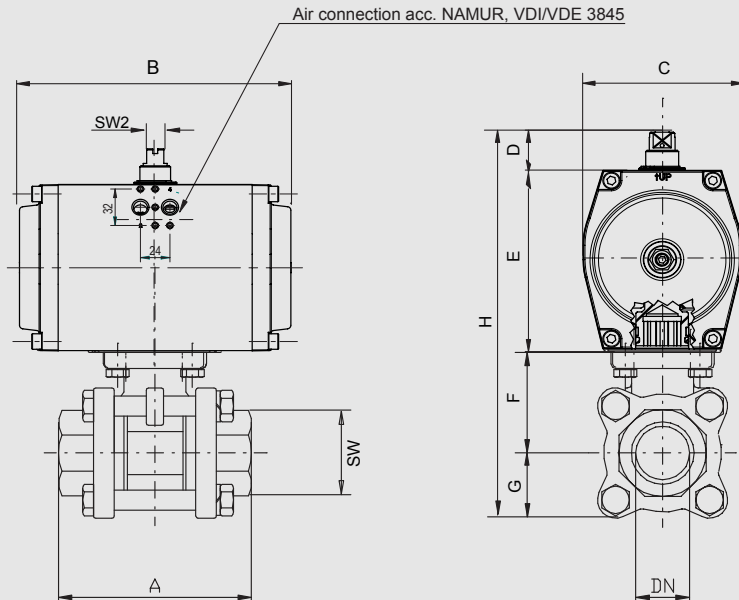

PKH.EP.E3.I	Nominal width [mm]		max. press. [bar]	M(1) + 30% [Nm]	Flange	square	Pneumatic actuator	Dimension [mm] and weight [kg]										Order no. (2)	
	DN	Rp						PN	A	B	C	D	E	F	G	H	SW 1		SW 2
double acting	15	1/2"	63	69,1	F03/F04	9	GTKB.52x90	75	133	68,5	30	74	40	24	168	29	10	1,70	350.510
	15	1/2"	63	69,1	F03/F04	9	GTKB.43x90	75	116	61,5	30	65	40	24	159	29	10	1,40	350.510/1
	20	3/4"	63	11,7	F03/F04	9	GTKB.52x90	80	133	68,5	30	74	44	27	175	35	10	1,80	350.511
	20	3/4"	63	11,7	F03/F04	9	GTKB.43x90	80	116	61,5	30	65	44	27	166	35	10	1,50	350.511/1
	25	1"	63	16,9	F04/F05	11	GTKB.63x90	90	133	68,5	30	77	50	30	187	41	10	2,80	350.512
	32	1 1/4"	63	26,0	F04/F05	11	GTKB.63x90	110	137	80,0	30	88	58	37	213	50	10	3,50	350.513
	40	1 1/2"	63	36,4	F05/F07	14	GTKB.63x90	120	137	80,0	30	88	68	40	226	58	10	4,40	350.514
	50	2"	63	48,1	F05/F07	14	GTKB.75x90	140	161	92,5	30	100	77	50	257	74	10	6,85	350.515
	65	2 1/2"	63	63,7	F07/F10	17	GTKB.83x90	185	180	99,5	30	108	98	62	298	89	10	12,0	350.516
80	3"	63	70,2	F07/F10	17	GTKB.92x90	205	209	110,5	30	117	110	82	339	104	14	17,6	350.517	
single acting, NC	15	1/2"	63	9,1	F03/F04	9	GTKB.52x90.09	75	133	68,5	30	74	40	24	168	24	10	1,85	350.520
	15	1/2"	63	9,1	F03/F04	9	GTKB.43x90.09	75	116	61,5	30	65	40	24	159	24	10	1,60	350.520/1
	20	3/4"	63	11,7	F03/F04	9	GTKB.52x90.10	80	133	68,5	30	74	44	27	175	30	10	1,90	350.521
	25	1"	63	16,9	F04/F05	11	GTKB.63x90.10	90	137	80,0	30	88	52	33	203	37	10	2,95	350.522
	32	1 1/4"	63	26,0	F04/F05	11	GTKB.75x90.10	110	161	92,5	30	100	58	37	225	40	10	4,50	350.523
	40	1 1/2"	63	36,4	F05/F07	14	GTKB.83x90.10	120	180	92,5	30	100	68	40	238	54	10	5,95	350.524
	50	2"	63	48,1	F05/F07	14	GTKB.92x90.10	140	209	110,5	30	117	77	50	274	68	14	9,90	350.525
	65	2 1/2"	63	63,7	F07/F10	17	GTKB.110x90.08	185	221	120,0	30	140	98	60	328	85	14	15,7	350.526
80	3"	63	70,2	F07/F10	17	GTKB.110x90.10	205	221	120,0	30	140	110	67	347	100	14	20,4	350.527	

(1) = Ball valve break torque incl. 30%.





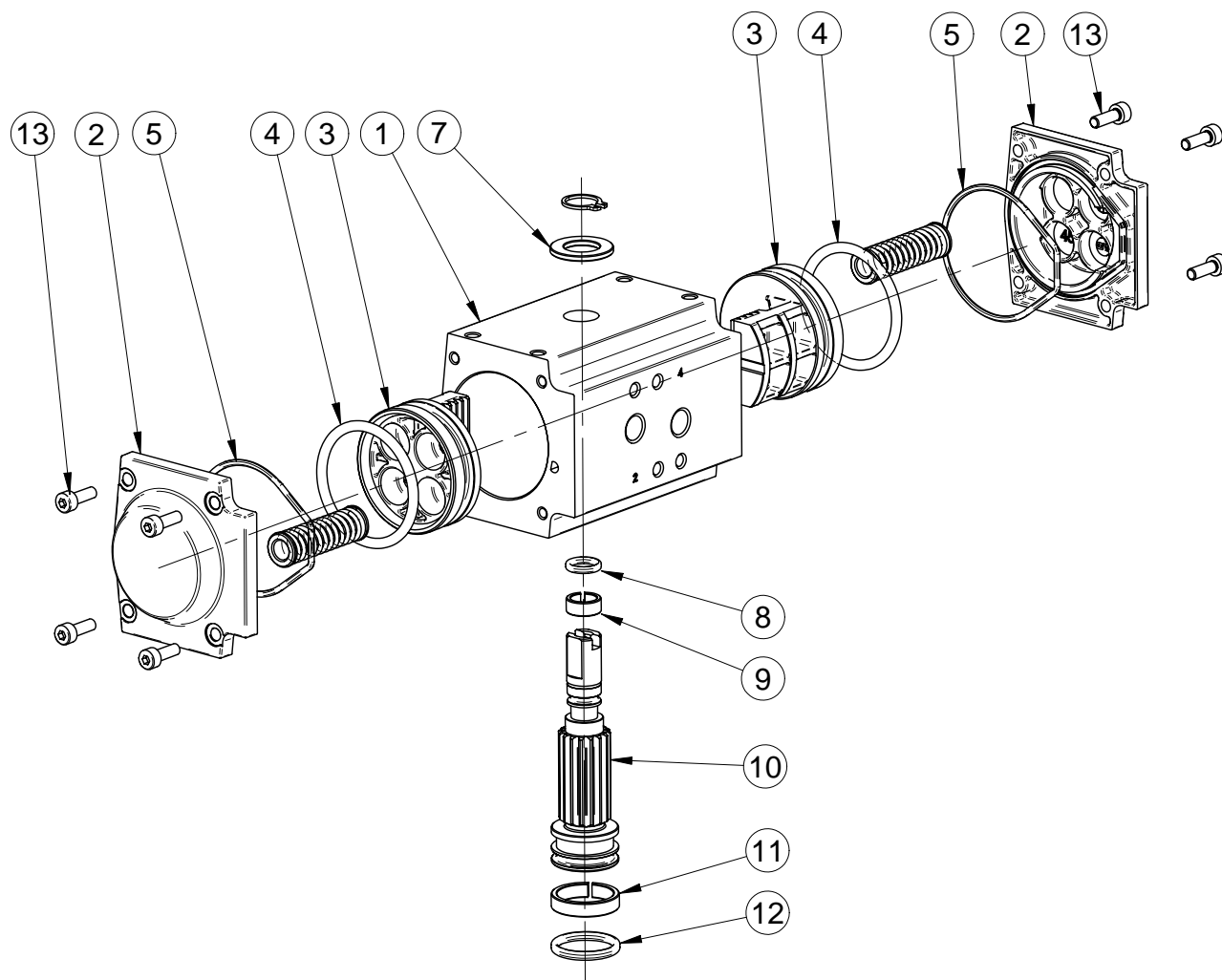





















(2) = Placeholder for designation NC (normal closed) or NO (normal open).

Materials - pneumatic actuators type GTK, GTX, GTW



MATERIAL LIST

type	description	materials
standard version	Body (1)	Extruded aluminium alloy astm 6063 anodized 10681
	End caps (2)	Die-cast aluminium alloy EN AC-46100 UNI EN 1706:1999, color RAL 5015 (blue)
	Piston (3)	Die-cast aluminium alloy EN AC-46100 UNI EN 1706:1999
	O-Ring (5, 8, 12)	NBR 70 SH (Perbunan)
	Guide set (4, 7, 9, 11)	DELIRIN ISO 9988
	Pinion (10)	Steel 11SMNBP37, electroless nickel plated
	Screws (13)	Stainless steel AISI 304
chemical version	Body (1)	Extruded aluminium alloy astm 6063 anodized 10681, hardcoated and teflon
	End caps (2)	Die-cast aluminium alloy EN AC-46100 UNI EN 1706:1999, color RAL 5015 (blue)
	Pistons (3)	Die-cast aluminium alloy EN AC-46100 UNI EN 1706:1999
	O-Ring (5, 8, 12)	NBR 70 SH (Perbunan)
	Guide set (4, 7, 9, 11)	DELIRIN ISO 9988
	Pinion (10)	Stainless steel AISI 304
	Screws (13)	Stainless steel AISI 304

Schaltstellungen 3-Wege-Kugelhähne mit pneumatischen Stellantrieb			
Variante	Grundstellung 0°	Dreh- richtung	Schaltstellung 90°
L1			
L2			
T1			
T2			
T3			
T4			
T5			
T6			
T7			
T8	