



Precision pressure regulators

without air consumption

101229 ... 101232

G 1/4

0.1 to 1.0 bar
0.1 to 3.0 bar
0.2 to 6.0 bar
0.5 to 10.0 bar



Characteristics

Order Article No.	101229	101230	101231	101232
Order Type No.	637.71	637.72	637.73	637.74
Connection thread	G 1/4			
Gauge port size	G 1/4			
Type of construction	Diaphragm pressure regulator with self-relieving design			
Max. input pressure p ₁ [bar]	16 bar			
Control range p ₂ [bar]	0.1 to 1.0	0.1 to 3.0	0.5 to 6.0	0.5 to 10.0
Medium temperature [°C]	Max. 60			
Ambient temperature [°C]	Max. 60			
Mounting type	Panel mounting, hole Ø20.5 Bracket			
Weight [g]	788 (without gauge)			

Operation

- Air purity class 1 to ISO 8573-1

Materials

Part	Material
Head piece	Zinc – Z 410
Spring bonnet	Zinc – Z 410
Diaphragm	FPM
Valve cone, compl.	FPM
Pressure spring	Galvanised steel
Counter-pressure spring	Stainless steel
O-ring 16 x 2	NBR
Bottom screw	POM

Description

- Double nipples (G1/4) required for block mounting with other devices
- Pressure setting can be locked with lock nut
- Flow direction indicated by arrows
- **Entry in direction of arrow**
- Pressure gauge **not** included, can be mounted at both ends
- Panel mounting with nut on cover
- Wall mounting with mounting bracket on housing
- Connection thread to ISO 228

Applications

- Precise preselection of working pressure
- Control range with high resolution, for use in pneumatic and compressed air applications

Standards and directives

98/37/EC (PED)	Scope: Art. 3, Section 3 Unmarked (acc. to Annex II, Diagram 2, Art. 3, Section 3 is applicable)
RoHS	Not applicable
ISO 4414	(Pneumatic fluid power – General rules and safety requirements for systems and their components)

Accessories

Designation	Order No.
Mounting bracket	H 84
Pressure gauge (optional) 0 to 1.6 bar	213-K
0 to 6.0 bar	216-KD
0 to 10.0 bar	217-KD

Main spare parts

On request

Dimensions [mm]

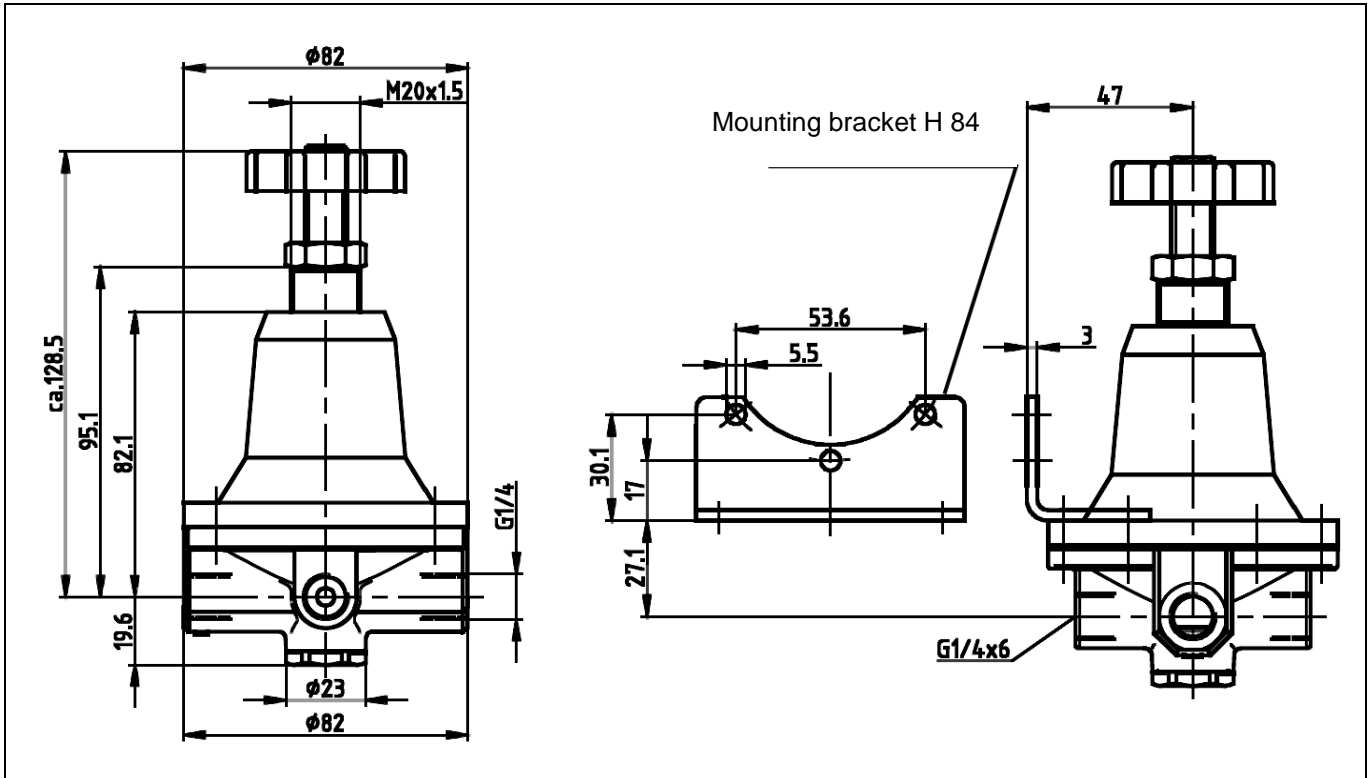

Flow characteristic

Regelbereich 0,1 - 1 bar

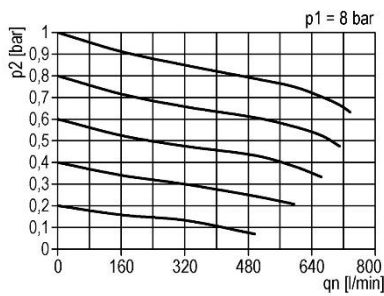

Flow characteristic

Regelbereich 0,2 - 6 bar

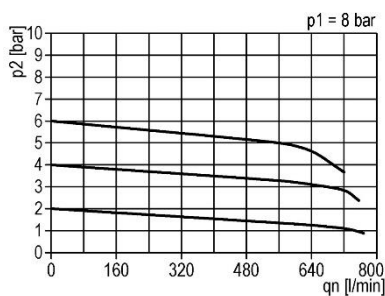

Hysteresis

Hysteresis of p_2 as a function of rising (falling) p_1 with a constant draw-off quantity Q_N 20 l/min
Basic setting (starting point): p_1 : 8.0 bar / p_2 : 2.0 bar

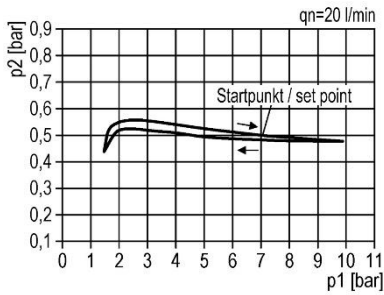

Hysteresis

Hysteresis of p_2 as a function of rising (falling) p_1 with a constant draw-off quantity Q_N 20 l/min
Basic setting (starting point): p_1 : 8.0 bar / p_2 : 2.0 bar

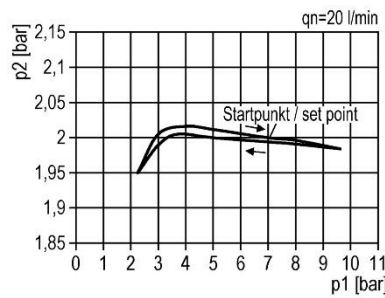

Flow characteristic

Regelbereich 0,5 - 10 bar

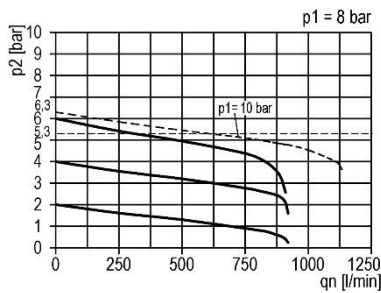

Flow characteristic

Regelbereich 0,1 - 3 bar

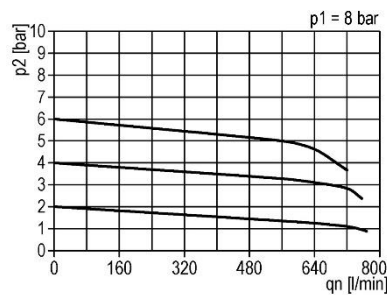

Hysteresis

Hysteresis of p_2 as a function of rising (falling) p_1 with a constant draw-off quantity Q_N 20 l/min
Basic setting (starting point): p_1 : 8.0 bar / p_2 : 2.0 bar

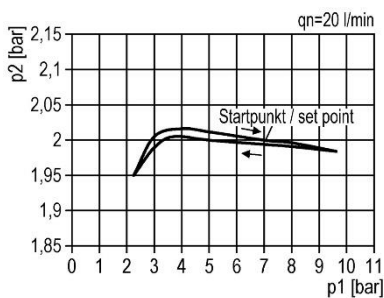

Hysteresis

Hysteresis of p_2 as a function of rising (falling) p_1 with a constant draw-off quantity Q_N 20 l/min
Basic setting (starting point): p_1 : 8.0 bar / p_2 : 2.0 bar

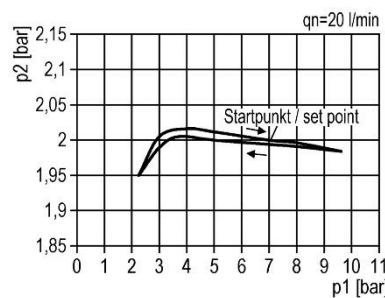

Durchflussmengen

Durchflussmengen bei $p_1=8$ bar

Artikel-Nr.		101229	101230	101231	101232
Ausgangsdruck p_2		1 bar	2 bar	6 bar	2 bar
Nenndurchfluss ($\Delta p=1$ bar)	l/min	740	740	540	500