

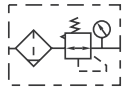

»G-mini« Series

GC 05, GC 06

Symbol



Product features

- Reversible diaphragm pressure regulators, independent of inlet pressure, with self-relieving design, combined with a centrifugal separator.
- The pressure setting can be locked by pushing the button down.

Specifications / Technical data

Art. No.	Size 200	
	GC 05	GC 06
Fluid	Air	
Port size	1/8"	1/4"
Filtering grade	5 µm (40 µm on request)	
Pressure range	1.5 to 9 bar (0.15 to 0.9 MPa, 20 to 130 psi)	
Proof pressure	15 bar (1.5 MPa, 215 psi)	
Temperature range	-20 to 70 °C	
Capacity of drain bowl	10 cm ³	
Weight	220 g	

Ordering information

Art. No.	Type
GC 05, GC 06	Filter regulators with polycarbonate bowl and »HW« mounting bracket, semi-automatic drain valve

Pressure chart

GC 05, GC 06

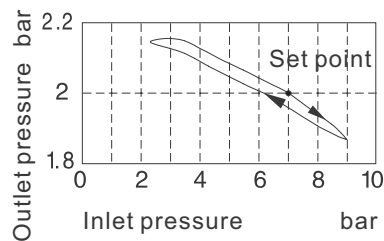

Flow chart

GC 05, GC 06

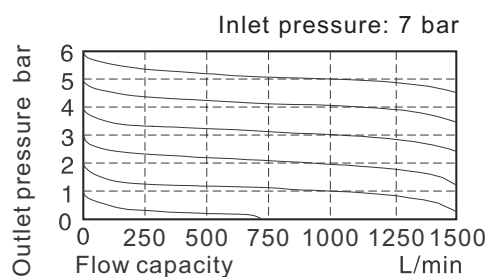

»G-mini« Series

GC 05, GC 06

Body dimensions

GC 05, GC 06

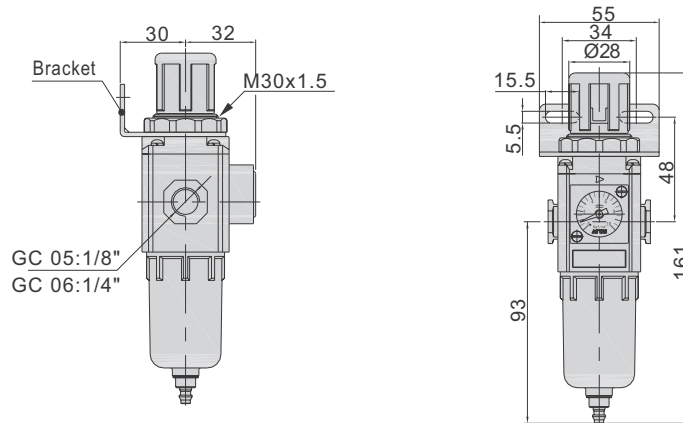

Selection of drain mode

Semi-auto drain

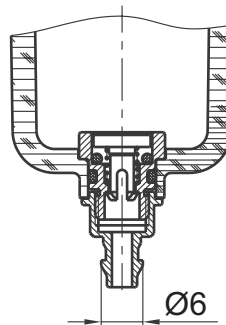

Components and materials

GC 05, GC 06

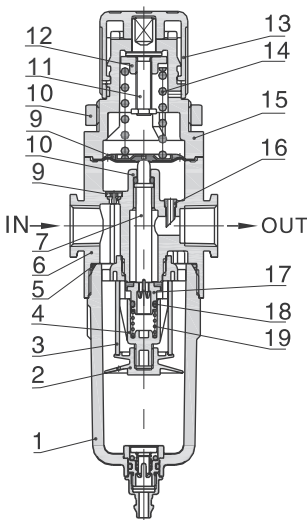











Semi-auto drain

No.	Item	Material
1	Drain bowl	PC
2	Umbrella baffle	POM
3	Filter core	Makrolon fiber: (5 µm)
4	Air guider	POM
5	O-ring	NBR
6	Body of filter & regulator	Aluminum alloy
7	Adjusting spool	POM
8	O-ring	NBR
9	Diaphragm	Stainless steel & NBR
10	Fixation ring nut	PC
11	Adjusting spindle	Steel
12	Regulator nut	Steel
13	Pressure adjusting knob	POM
14	Spring	Spring steel
15	Adjusting Seat	PC
16	Feedback tube	POM
17	Adjusting plug	Brass & NBR
18	O-ring	NBR
19	Spring	Stainless steel

»G-mini« Series

GC 05, GC 06

Accessories

	Art. No.	Type
	GR 05 100	Set of wearing parts for pressure regulators/filter regulators = discontinued product. No longer available.
	GR 05 110	Replacement diaphragm = discontinued product. No longer available.
	GR 05 120	Adapter plate for mounting standard pressure gauges (round)
	110.46-KD	Standard pressure gauges
	GF 05 300	Polycarbonate bowl with semi-automatic drain valve for filters/filter regulators
	GF 05 400	Filter element 5 µm
	HW 200	Mounting bracket
	UB 200	Joiner without wall mounting
	LB 200	Joiner with wall mounting, 1 drilled hole
	TB 200	Joiner with wall mounting, 2 drilled holes