

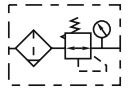

»G« Series

GC 11–GC 55 A

Symbol



Product features

- Reversible diaphragm pressure regulators, independent of inlet pressure, with self-relieving design, combined with a centrifugal separator.
- The pressure setting can be locked by pushing the button down.

Specifications / Technical data

Art. No.	Size 300			Size 400		Size 600	
	GC 11, GC 11 A	GC 12, GC 12 A	GC 13, GC 13 A	GC 32, GC 32 A	GC 33, GC 33 A	GC 34, GC 34 A	GC 55, GC 55 A
Fluid	Air						
Port size	1/4"	3/8"	1/2"	3/8"	1/2"	3/4"	1"
Filtering grade	5 µm (40 µm on request)						
Pressure range	1.5 to 9 bar (0.15 to 0.9 MPa, 20 to 130 psi)						
Proof pressure	15 bar (1.5 MPa, 215 psi)						
Temperature range	-20 to 70 °C						
Capacity of drain bowl	40 cm ³			80 cm ³		230 cm ³	
Weight	500 g			1030 g		2400 g	

Ordering information

Art. No.	Type
GC 11–GC 13, GC 32, GC 33	Filter regulators with polycarbonate bowl, bowl guard and »HW« mounting bracket, semi-automatic drain valve
GC 34, GC 55	Filter regulators with metal bowl, sight glass and »HW« mounting bracket, semi-automatic drain valve
GC 11 A–GC 13 A, GC 32 A, GC 33 A	Filter regulators with polycarbonate bowl, bowl guard and »HW« mounting bracket, fully-automatic drain valve
GC 34 A, GC 55 A	Filter regulators with metal bowl, sight glass and »HW« mounting bracket, fully-automatic drain valve

»G« Series

GC 11–GC 55 A

Pressure chart

GC 11–GC 13, GC 11 A–GC 13 A

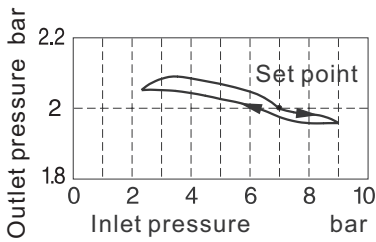

GC 32, GC 33, GC 32 A, GC 33 A

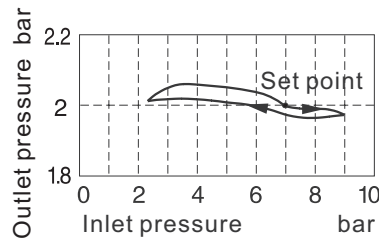

GC 34, GC 55, GC 34 A, GC 55 A

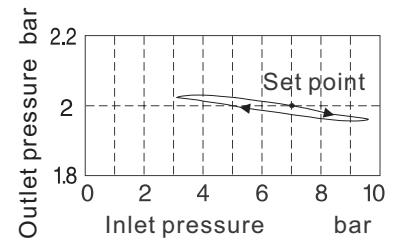

Flow chart

GC 12*, GC 13, GC 12 A, GC 13 A

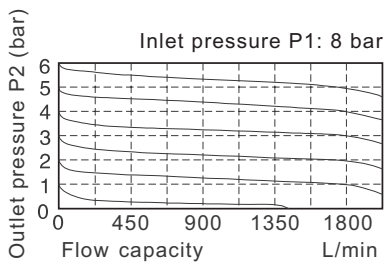

GC 32, GC 33, GC 32 A, GC 33 A

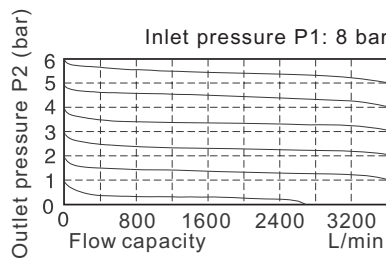

GC 34, GC 55, GC 34 A, GC 55 A

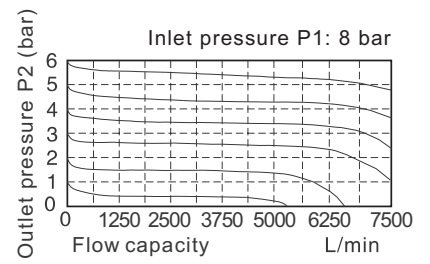

*Flow rates GC 11, GC 11 A approx. 17% less

Body dimensions

GC 11–GC 13, GC 32, GC 33, GC 11 A–GC 13 A, GC 32 A, GC 33 A

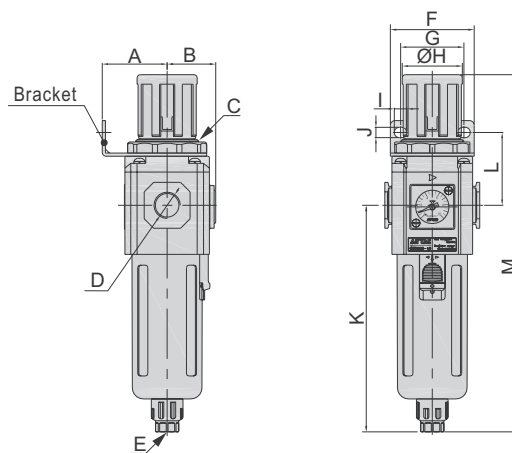

Art. No.	A	B	C	D	E	F	G	H	I	J	K	L	M
GC 11, GC 11 A	41	31	M40x1.5	1/4"	G1/8	53	40	38	8	6.5	143	46	225.5
GC 12, GC 12 A	41	31	M40x1.5	3/8"	G1/8	53	40	38	8	6.5	143	46	225.5
GC 13, GC 13 A	41	31	M40x1.5	1/2"	G1/8	53	40	38	8	6.5	143	46	225.5
GC 32, GC 32 A	50	40	M55x2.0	3/8"	G1/4	72	52	52	11	8.5	166.5	53	270.5
GC 33, GC 33 A	50	40	M55x2.0	1/2"	G1/4	72	52	52	11	8.5	166.5	53	270.5

(Values in mm, exception D = inch)

»G« Series

GC 11–GC 55 A

Body dimensions

GC 34, GC 55

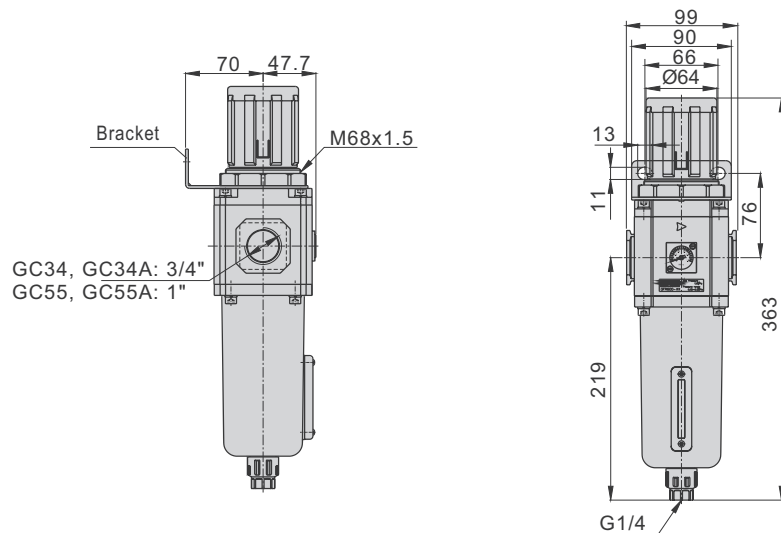

Components and materials

GC 11–GC 55

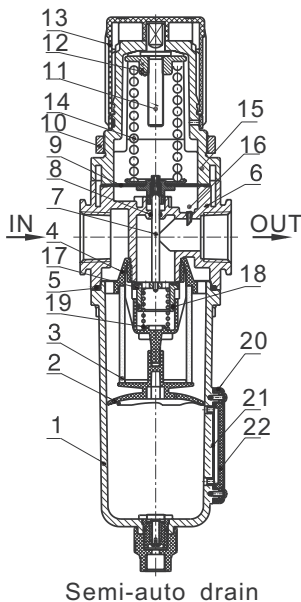













No.	Item	Material
1	Drain bowl	Aluminum alloy (GC 34, GC 55, GC 34 A, GC 55 A) PC (Other)
2	Umbrella baffle	High viscosity POM
3	Filter core	Agglomerated by bronze grain (GC 34, GC 55, GC 34 A, GC 55 A) Makrolon fiber: (5 µm)
4	Air guider	High viscosity POM
5	O-ring	NBR
6	Body of filter & regulator	Aluminum alloy
7	Adjusting spool	Brass (GC 34, GC 55, GC 34 A, GC 55 A) POM (other)
8	O-ring	NBR
9	Diaphragm	Stainless steel & Rubber
10	Fixation ring nut	Aluminum alloy (GC 34, GC 55, GC 34 A, GC 55 A) PC (other)
11	Adjusting spindle	Steel
12	Regulator nut	Steel
13	Pressure adjusting knob	POM
14	Spring	Spring steel
15	Adjusting Seat	Aluminum alloy (GC 34, GC 55, GC 34 A, GC 55 A) PC (other)
16	Feedback tube	POM
17	Adjusting plug	Brass & Rubber
18	O-ring	NBR
19	Spring	Stainless steel
20	Liquid meter cover	Steel
21	Liquid meter seal	FKM
22	Liquid meter inside cover	PC

»G« Series

GC 11–GC 55 A

Accessories

	For GC 11–GC 13 and GC 11 A–GC 13 A	For GC 32, GC 33, GC 32 A and GC 33 A	For GC 34, GC 55, GC 34 A and GC 55 A	Type
	Art. No.	Art. No.	Art. No.	
	GR 11 100	GR 32 100	GR 34 100	Set of wearing parts for pressure regulators/filter regulators
	GR 11 110	GR 32 110	GR 34 110	Replacement diaphragm
	GR 05 120	GR 32 120	GR 32 120	Adapter plate for mounting standard pressure gauges (round)
	110.46-KD	206-KD	206-KD	Standard pressure gauges
	GF 11 300	GF 32 300	GF 34 300	Polycarbonate bowl with semi-automatic drain valve for filters/filter regulators
	GF 11 600	GF 32 600	GF 34 600	Polycarbonate bowl with automatic drain valve for filters/filter regulators
	GF 11 500	GF 32 500	–	Protective cage
	GF 11 400	GF 32 400	GF 34 400	Filter element 5 µm
	HW 300	HW 400	HW 600	Mounting bracket
	UB 300	UB 400	UB 600	Joiner without wall mounting
	LB 300	LB 400	LB 600	Joiner with wall mounting, 1 drilled hole
	TB 300	TB 400	TB 600	Joiner with wall mounting, 2 drilled holes

(Pictures are similar to product.)