

»GA« Series

GAC 11–GAC 55 A

Symbol

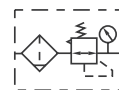

Product features

- Reversible diaphragm pressure regulators, independent of inlet pressure, with self-relieving design, combined with a centrifugal separator.
- The pressure setting can be locked by pushing the button down.

Specifications / Technical data

Type	Size 300			Size 400		Size 600	
	GAC 11, GAC 11 A	GAC 12, GAC 12 A	GAC 13, GAC 13 A	GAC 32, GAC 32 A	GAC 33, GAC 33 A	GAC 34, GAC 34 A	GAC 55, GAC 55 A
Fluid	Air						
Port size	1/4"	3/8"	1/2"	3/8"	1/2"	3/4"	1"
Filtering grade	5 µm (40 µm on request)						
Pressure range	1.5 to 9 bar (0.15 to 0.9 MPa, 20 to 130 psi)						
Inlet pressure	10 bar (1.0 MPa, 145 psi)						
Temperature range	-5 to 70 °C						
Capacity of drain bowl	60 cm ³			100 cm ³		205 cm ³	
Weight	500 g			880 g		1880 g	

Ordering information

Type	description
GAC 11–GAC 13, GAC 32, GAC 33	Filter regulators with polycarbonate bowl, bowl guard and »HW« mounting bracket, semi-automatic drain valve
GAC 34, GAC 55	Filter regulators with metal bowl, sight glass and »HW« mounting bracket, semi-automatic drain valve
GAC 11 A–GAC 13 A, GAC 32 A, GAC 33 A	Filter regulators with polycarbonate bowl, bowl guard and »HW« mounting bracket, fully-automatic drain valve
GAC 34 A, GAC 55 A	Filter regulators with metal bowl, sight glass and »HW« mounting bracket, fully-automatic drain valve

»GA« Series

GAC 11–GAC 55 A

Pressure chart

GAC 11–GAC 13, GAC 11 A–GAC 13 A

GAC 32, GAC 33, GAC 32 A, GAC 33 A

GAC 34, GAC 55, GAC 34 A, GAC 55 A

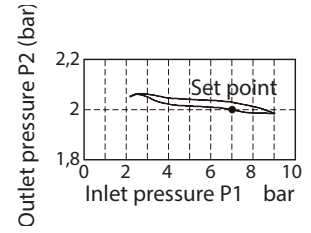
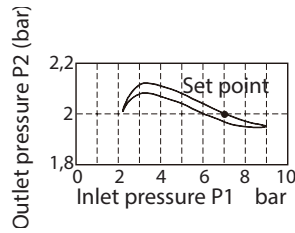
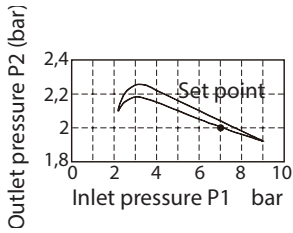

Flow chart

GC 12*, GC 13, GC 12 A, GC 13 A

GC 32, GC 33, GC 32 A, GC 33 A

GC 34, GC 55, GC 34 A, GC 55 A

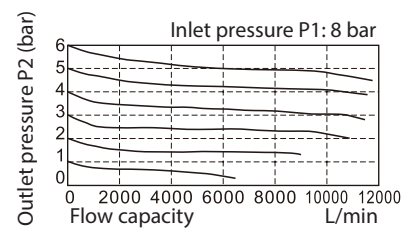
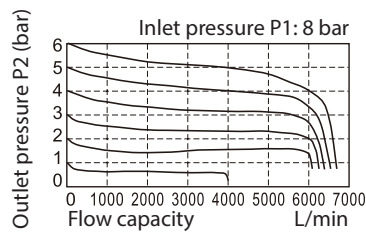
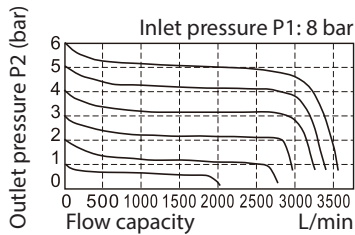

*Flow rates GAC 11, GAC 11 A approx. 17% less

»GA« Series

GAC 11–GAC 55 A

Body dimensions

GAC 11–GAC 13, GAC 32, GAC 33, GAC 11 A–GAC 13 A, GAC 32 A, GAC 33 A

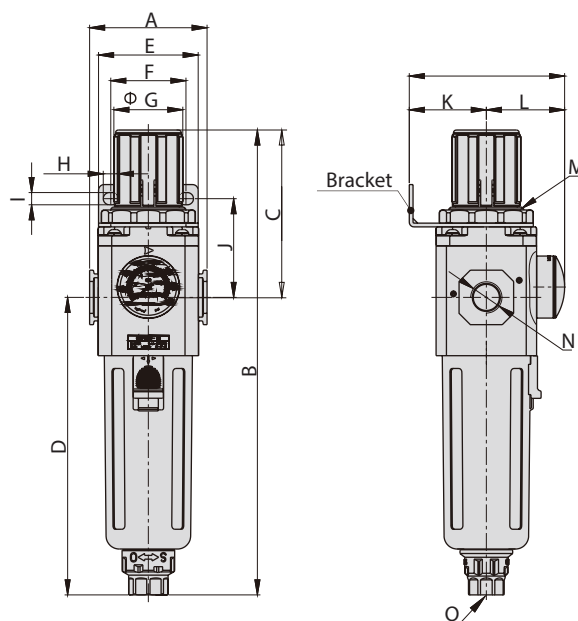

Article number	Type	A	B	C	D	E	F	G	H	I	J	K	L	M	N	O
178470, 175475	GAC 11, GAC 11 A	62,5	247,0	89,0	158,0	53,0	40,0	38,0	8,0	6,5	52,5	41,0	41,5	M40x1,5	1/4"	G1/4
178471, 175476	GAC 12, GAC 12 A	62,5	247,0	89,0	158,0	53,0	40,0	38,0	8,0	6,5	52,5	41,0	41,5	M40x1,5	3/8"	G1/4
178472, 175477	GAC 13, GAC 13 A	62,5	247,0	89,0	158,0	53,0	40,0	38,0	8,0	6,5	52,5	41,0	41,5	M40x1,5	1/2"	G1/4
178473, 175478	GAC 32, GAC 32 A	80,0	285,5	108,0	177,5	72,0	55,0	52,0	11,0	8,5	57,0	50,0	49,0	M55x2,0	3/8"	G1/4
178474, 175479	GAC 33, GAC 33 A	80,0	285,5	108,0	177,5	72,0	55,0	52,0	11,0	8,5	57,0	50,0	49,0	M55x2,0	1/2"	G1/4
178480, 178482	GAC 34, GAC 34 A	100,0	336,5	131,5	205,0	90,0	66,0	59,0	13,0	11,0	76,0	70,0	58,0	M62x1,5	3/4"	G1/4
178481, 178483	GAC 55, GAC 55 A	100,0	336,5	131,5	205,0	90,0	66,0	59,0	13,0	11,0	76,0	70,0	58,0	M62x1,5	1"	G1/4

Values in mm, exception N = inch

»GA« Series

GAC 11–GAC 55 A

Components and materials



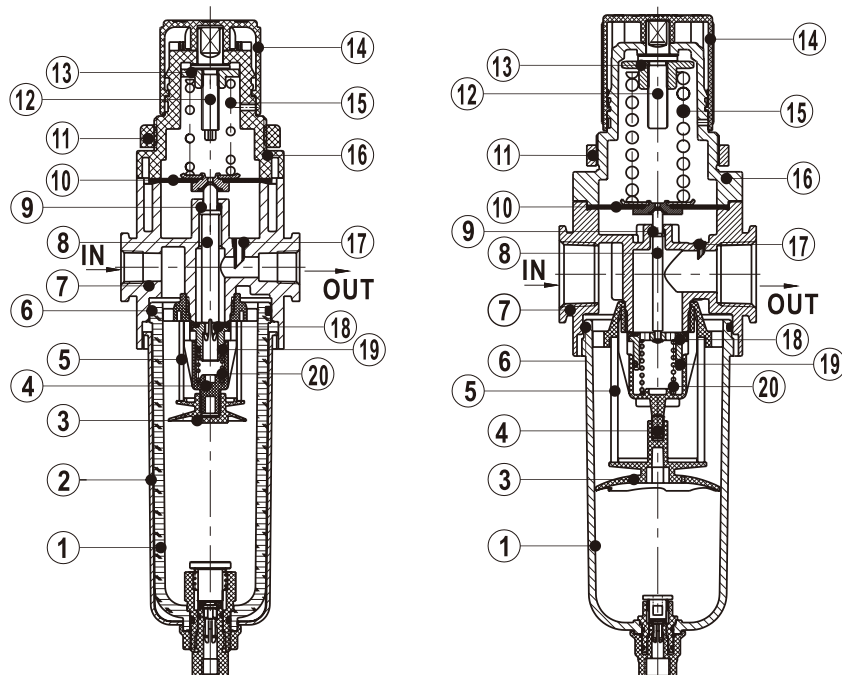



No.	Item	Material
1	Drain bowl	Aluminum alloy / PC
2	Meter cover	SPCC
3	Umbrella baffle	High viscosity POM
4	Air guider	High viscosity POM
5	Filter core	HDPE
6	O-ring	NBR
7	Body of filter-regulator	Aluminum alloy
8	Adjusting spool	Brass (GAC 34 - GAC 55 A) / POM (GAC 11 - 33 A)
9	O-ring	NBR
10	Diaphragm	NBR
11	Fixation ring cap	Aluminum alloy (GAC 34 - GAC 55 A) / POM (GAC 11 - 33 A)
12	Adjusting spindle	Steel
13	Regulator nut	Steel
14	Pressure knob	POM
15	Spring	SWPB
16	Adjusting seat	Aluminum alloy (GAC 34 - GAC 55 A) / POM (GAC 11 - 33 A)
17	Feedback tube	POM
18	Adjusting plug	Brass & Rubber
19	O-ring	NBR
20	Spring	SWPB



»GA« Series

GAC 11–GAC 55 A

Accessories

	GAC 11–GAC 13 and GAC 11 A–GAC 13 A		GAC 32, GAC 33, GAC 32 A and GAC 33 A		GAC 34, GAC 55, GAC 34 A and GAC 55 A		description
	Art. No.	Type	Art. No.	Type	Art. No.	Type	
no image available	179141	GAR 11 120	179142	GAR 32 120	179142	GAR 32 120	Adapter plate for mounting standard pressure gauges
	101672	110.46-KD	101677	206-KD	101677	206-KD	Standard pressure gauges
	179146	GAF 11 400	179144	GAF 32 400	179143	GF 34 400	Filter element 5 µm
	116482	HW 300	116484	HW 400	116486	HW 600	Mounting bracket
	116613	UB 300	116614	UB 400	116615	UB 600	Joiner without wall mounting
	116516	LB 300	116517	LB 400	116518	LB 600	Joiner with wall mounting, 1 drilled hole
	116609	TB 300	116610	TB 400	116611	TB 600	Joiner with wall mounting, 2 drilled holes