

»G« Series

GCL 11–GCL 55 A

Symbol

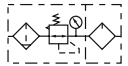

Product features

Two-piece service units consisting of a diaphragm pressure regulator, independent of inlet pressure, with self-relieving design, combined with a centrifugal separator and a proportional lubricator.

Specifications / Technical data

| Art. No. | Size 300 | | | Size 400 | | Size 600 | | |
|------------------------|--|--------------------|--------------------|---------------------|--------------------|---------------------|--------------------|------------------|
| | GCL 11 GCL 11 A | GCL 12 GCL 12 A | GCL 13 GCL 13 A | GCL 32 GCL 32 A | GCL 33 GCL 33 A | GCL 34 GCL 34 A | GCL 55 GCL 55 A | |
| Fluid | Air | | | | | | | |
| Port size | 1/4" | 3/8" | 1/2" | 3/8" | 1/2" | 3/4" | 1" | |
| Filtering grade | 5 µm (40 µm on request) | | | | | | | |
| Pressure range | 1.5 to 9 bar (0.15 to 0.9 MPa, 20 to 130 psi) | | | | | | | |
| Proof pressure | 15 bar (1.5 MPa, 215 psi) | | | | | | | |
| Temperature range | -20 to 70 °C | | | | | | | |
| Capacity of drain bowl | 40 cm ³ | | | 80 cm ³ | | 230 cm ³ | | |
| Capacity of oil bowl | 75 cm ³ | | | 160 cm ³ | | 380 cm ³ | | |
| Recommended lubricant | Mineral oil, viscosity 32 cSt, acc. to DIN 51524 - ISO VG 32 | | | | | | | |
| Weight | 980 g | | | 1950 g | | 4320 g | | |
| Constitute | Filter-regulator | GC 11 GC 11 A | GC 12 GC 12 A | GC 13 GC 13 A | GC 32 GC 32 A | GC 33 GC 33 A | GC 34 GC 34 A | GC 55 GC 55 A |
| | Lubricator | GL 11 | GL 12 | GL 13 | GL 32 | GL 33 | GL 34 | GL 55 |

Ordering information

| Art. No. | Type |
|--|--|
| GCL 11–GCL 13, GCL 32, GCL 33 | Service units, 2-piece with polycarbonate bowl, bowl guard and joiner for wall mounting, semi-automatic drain valve |
| GCL 34, GCL 55 | Service units, 2-piece with metal bowl, sight glass and joiner for wall mounting, semi-automatic drain valve |
| GCL 11 A–GCL 13 A, GCL 32 A, GCL 33 A | Service units, 2-piece with polycarbonate bowl, bowl guard and joiner for wall mounting, fully-automatic drain valve |
| GCL 34 A, GCL 55 A | Service units, 2-piece with metal bowl, sight glass and joiner for wall mounting, fully-automatic drain valve |

»G« Series

GCL 11–GCL 55 A

Pressure chart

GCL 11–GCL 13, GCL 11 A–GCL 13 A

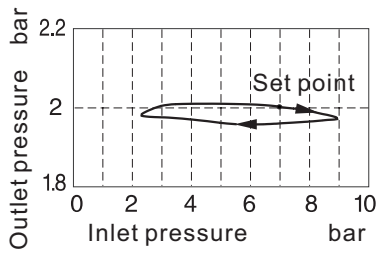

GCL 32, GCL 33, GCL 32 A, GCL 33 A

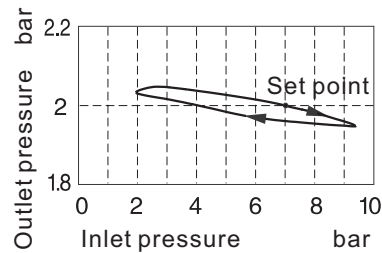

GCL 34, GCL 55, GCL 34 A, GCL 55 A

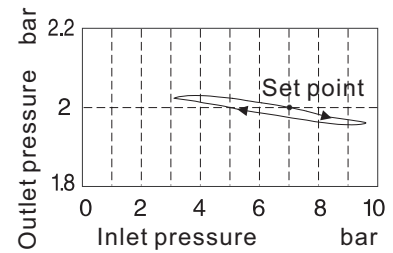

Flow chart

GCL 12*, GCL 13, GCL 12 A, GCL 13 A

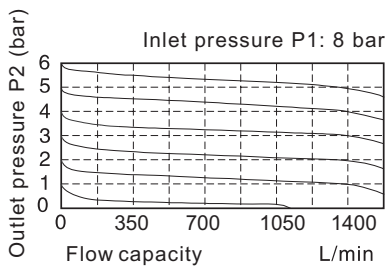

GCL 32, GCL 33, GCL 32 A, GCL 33 A

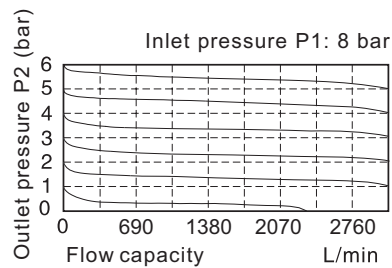

GCL 34, GCL 55, GCL 34 A, GCL 55 A

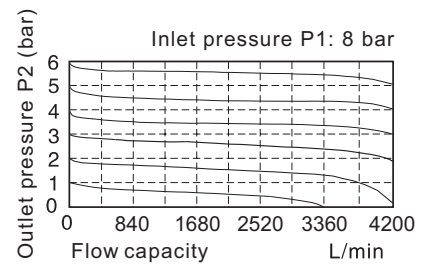

*Flow rates GCL 11, GCL 11 A approx. 22% less

Body dimensions

GCL 11–GCL 13, GCL 32, GCL 33, GCL 11 A–GCL 13 A, GCL 32 A, GCL 33 A

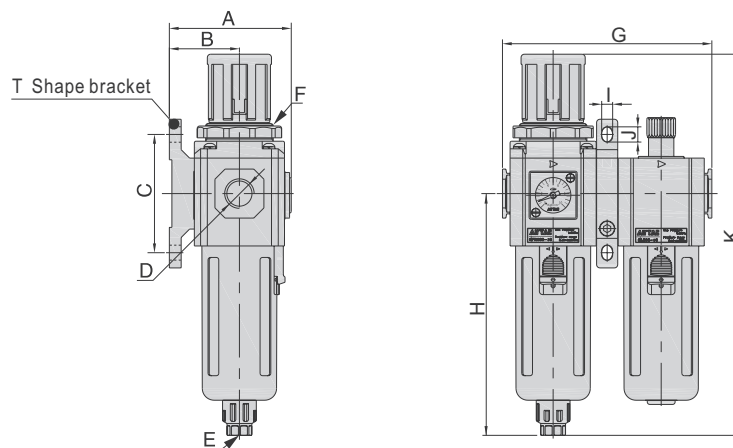

| Art. No. | A | B | C | D | E | F | G | H | I | J | K |
|------------------|----|------|----|------|------|---------|-----|-------|-----|----|-------|
| GCL 11, GCL 11 A | 72 | 41.5 | 70 | 1/4" | G1/8 | M40x1.5 | 124 | 143 | 6.5 | 9 | 225.5 |
| GCL 12, GCL 12 A | 72 | 41.5 | 70 | 3/8" | G1/8 | M40x1.5 | 124 | 143 | 6.5 | 9 | 225.5 |
| GCL 13, GCL 13 A | 72 | 41.5 | 70 | 1/2" | G1/8 | M40x1.5 | 124 | 143 | 6.5 | 9 | 225.5 |
| GCL 32, GCL 32 A | 89 | 50 | 80 | 3/8" | G1/4 | M55x2.0 | 164 | 165.5 | 8.5 | 12 | 269.5 |
| GCL 33, GCL 33 A | 89 | 50 | 80 | 1/2" | G1/4 | M55x2.0 | 164 | 165.5 | 8.5 | 12 | 269.5 |

(Values in mm, exception D = inch)

»G« Series

GCL 11–GCL 55 A

Body dimensions

GCL 34, GCL 55, GCL 34 A, GCL 55 A

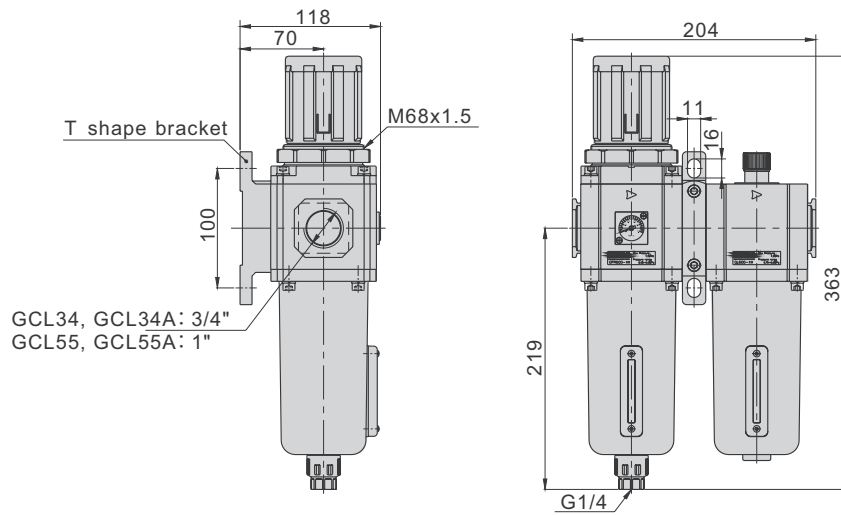

Components and materials

GCL 11–GCL 55 A

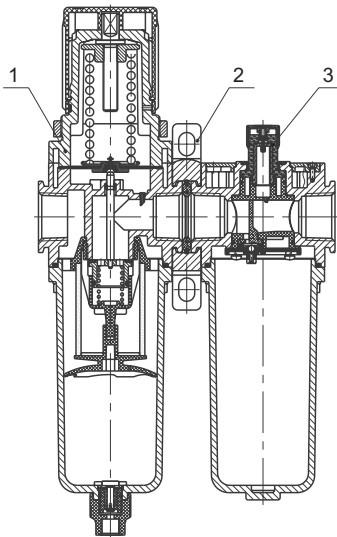















| No. | Item | Material (body) |
|-----|---------------------------|-----------------|
| 1 | G series filter-regulator | Aluminium alloy |
| 2 | Bracket | Aluminium alloy |
| 3 | G series lubricator | Aluminium alloy |

»G« Series

GCL 11–GCL 55 A

Accessories

| | For GCL 11–GCL 13 and GCL 11 A–GCL 13 A | For GCL 32, GCL 33, GCL 32 A and GCL 33 A | For GCL 34, GCL 55, GCL 34 A and GCL 55 A | Type |
|---|---|--|--|--|
| | Art. No. | Art. No. | Art. No. | |
|  | GR 11 100 | GR 32 100 | GR 34 100 | Set of wearing parts for pressure regulators/filter regulators |
|  | GR 11 110 | GR 32 110 | GR 34 110 | Replacement diaphragm |
|  | GR 05 120 | GR 32 120 | GR 32 120 | Adapter plate for mounting standard pressure gauges (round) |
|  | 110.46-KD | 206-KD | 206-KD | Standard pressure gauges |
|  | GF 11 300 | GF 32 300 | GF 34 300 | Polycarbonate bowl with semi-automatic drain valve for filters/filter regulators |
|  | GF 11 600 | GF 32 600 | GF 34 600 | Polycarbonate bowl with automatic drain valve for filters/filter regulators |
|  | GF 11 500 | GF 32 500 | – | Protective cage |
|  | GF 11 400 | GF 32 400 | GF 34 400 | Filter element 5 µm |
|  | GL 11 200 | GL 32 200 | – | Polycarbonate bowl for oil-mist lubricators |
|  | GL 11 300 | GL 32 300 | – | Polycarbonate bowl with bowl guard for oil-mist lubricators |
|  | – | – | GL 34 M | Metal bowl with sight glass for oil-mist lubricators |
|  | HW 300 | HW 400 | HW 600 | Mounting bracket |
|  | UB 300 | UB 400 | UB 600 | Joiner without wall mounting |
|  | LB 300 | LB 400 | LB 600 | Joiner with wall mounting, 1 drilled hole |
|  | TB 300 | TB 400 | TB 600 | Joiner with wall mounting, 2 drilled holes |

(Pictures are similar to product.)